MED64

The most sensitive microelectrode array system
for *in vitro* extracellular electrophysiology

Product Manual

MED ThermoConnector

P/N: MED-CP04



ALPHA MED SCIENTIFIC

Information in this document is subject to change without notice.No part of this document may be reproduced or transmitted without the expressed written permission of Alpha MED Scientific Inc.

While every precaution has been taken in the preparation of this document, the publisher and the authors assume no responsibility for errors or omissions, or for damages resulting from the use of information contained in this document or from the use of programs and source code that may accompany it. In no event shall the publisher and the author be liable for any loss of profit or any other commercial damage caused or alleged to have been caused directly or indirectly by this document.

© 2016 Alpha MED Scientific Inc. All rights reserved.

Version: 1.00; December 1, 2016

Alpha MED Scientific Inc.

Saito Bio-Incubator 209, 7-7-15, Saito-asagi,
Ibaraki, Osaka 567-0085, Japan

E-mail: support@med64.com

Website: <http://www.med64.com>

Contents

1. Safety precautions	1
1-1. Placement	1
1-2. Voltage	1
1-3. Power cord protection	1
1-4. Foreign materials	1
1-5. Service	2
1-6. Environmental conditions	2
1-7 Maintenance	2
2. MED ThermoConnector and Functions	3
2-1. Components and functions	4
Connector unit	4
Temperature controller	4
Accessories	5
3. Installation	6
3-1. Orientation for the Connector unit	6
3-2. Installing the MED ThermoConnector	6
Installing with the perfusion system	9
Installing on a microscope stage	10
4. Instruction for use	11
4-1. Installing the MED Probe onto the MED ThermoConnector	11
Grounding the additional re. electrode (platinum wire)	12
4-2. Setting temperature	12
4-3. Recommended temperature and important notice to achieve a temperature stability	13

5. Maintenance	14
5-1. Cleaning of the contact pins.....	14
5-2. Cleaning of the perfusion pipe incorporated into the Connector unit	14
5-3. Re-connecting the Grounding cable for the Connector unit	15
5-4. Sterilization	16
5-5. Storage	16
6. Troubleshoot	17
7. Cautions	18
8. The terminal arrangement of electrodes on the MED Probe and the MED ThermoConnector	19
9. Warranty	20
10. Specifications	20

1. Safety precautions

Before using this unit please read these operating instructions carefully. Take special care to follow the warnings indicated on the unit itself as well as the safety suggestions listed below. Keep these precautions at hand for future reference.

1-1. Placement

- Avoid placing the unit in areas of:
 - direct sunlight.
 - high temperature.
 - high humidity.
 - excessive vibration.
 - uneven.

Such conditions might damage the connector component parts and thereby shorten the unit's service life.

1-2. Voltage

- A DC power source cannot be used. Be sure to check the power source carefully.

1-3. Power cord protection

- Avoid using AC power cords with cuts, scratches, or poor connectors, as this may result in fire or electric shock. Excessive bending, pulling or slicing of the cord should also be avoided.
- Do not pull on the cord when you are disconnecting the power. This could cause an electric shock. Grasp the plug firmly when you disconnect the power supply.
- Never touch the plug with wet hands as a serious electric shock could result.

1-4. Foreign materials

- Ensure that no foreign objects (e.g. - needles, coins, screwdrivers), accidentally fall into the unit. Otherwise, a serious electric shock, short circuit, or other malfunction could occur.
- Be extremely careful about spilling water or liquid on or into the unit, as a fire, short circuit, or electric shock can also occur. Disconnect the power plug and contact your dealer immediately if this occurs.
- Avoid spraying volatile chemicals (e.g.- insecticides, alcohol, paint thinner) on or into the unit. They contain flammable gases which can be ignited.
- Insecticides, alcohol, paint thinner and similar chemicals should never be used to clean the unit. They can cause flaking or cloudiness to the cabinet finish.

1-5. Service

- Never attempt to repair, disassemble or modify the unit if there seems to be a problem. A serious electric shock could result if you ignore this precautionary measure.
- If a problem occurs during operation (smoke is detected, etc.) contact your dealer immediately.
- Disconnect the power supply if the unit will not be used for a long time. Otherwise the unit's lifetime could be shortened.

Safety-related symbols used on equipment and documentation:

1-6. Environmental conditions

- Indoor use.
- Altitude up to 2000 m.
- Temperature: 20 - 30 °C.
- Maximum relative humidity 80% for temperatures up to 31 °C decreasing linearly to 50% relative humidity at 40 °C.
- Main supply voltage fluctuations not to exceed +/- 10% of the nominal voltage.

1-7. Maintenance

- Clean the cabinet, panel and controls with a soft cloth lightly moistened with mild detergent solution.
- Do not use any type of abrasive pad, scouring power or solvent such as alcohol or benzene.
- Supply voltage fluctuations must not to exceed +/- 10% of the nominal voltage.

2. MED ThermoConnector Components and Functions

The MED ThermoConnector (MED-CP04) is a Connector for the MED64-Basic, MED64-Plex 4/8 System. It connects the MED Probe to the MED64 Head Amplifier (MED-A64HE1S) allowing recording extracellular signals at 64 planar microelectrodes embedded in the MED Probe.

Heater and thermo sensor is incorporated into the bottom unit of the MED Connector, and warms the bath temperature in the MED Probe. The temperature is controlled and maintained by a dedicated temperature controller.

The bottom unit for the MED ThermoConnector has an aperture, and allows to observe your biological sample with a microscope during recording. It also incorporates an in-line solution heater for perfusion so that solution is warmed up before sent to the MED Probe chamber when the unit is used with perfusion system.

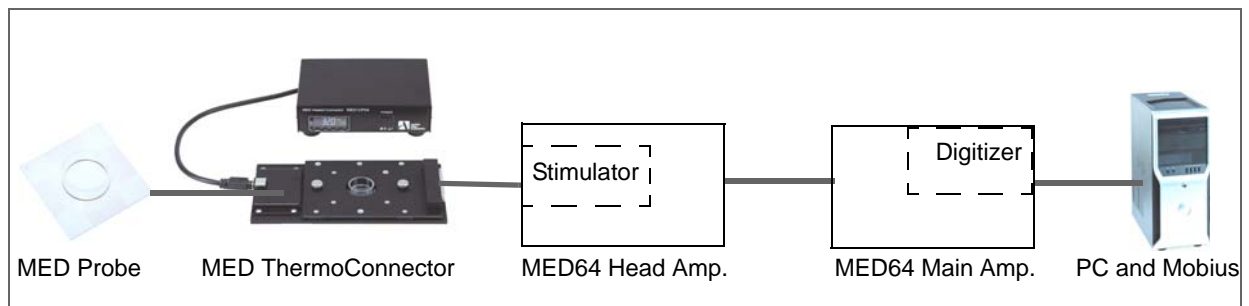

Figure 1. System diagram for the MED64-Basic System.

2-1. Components and their functions

Connector unit

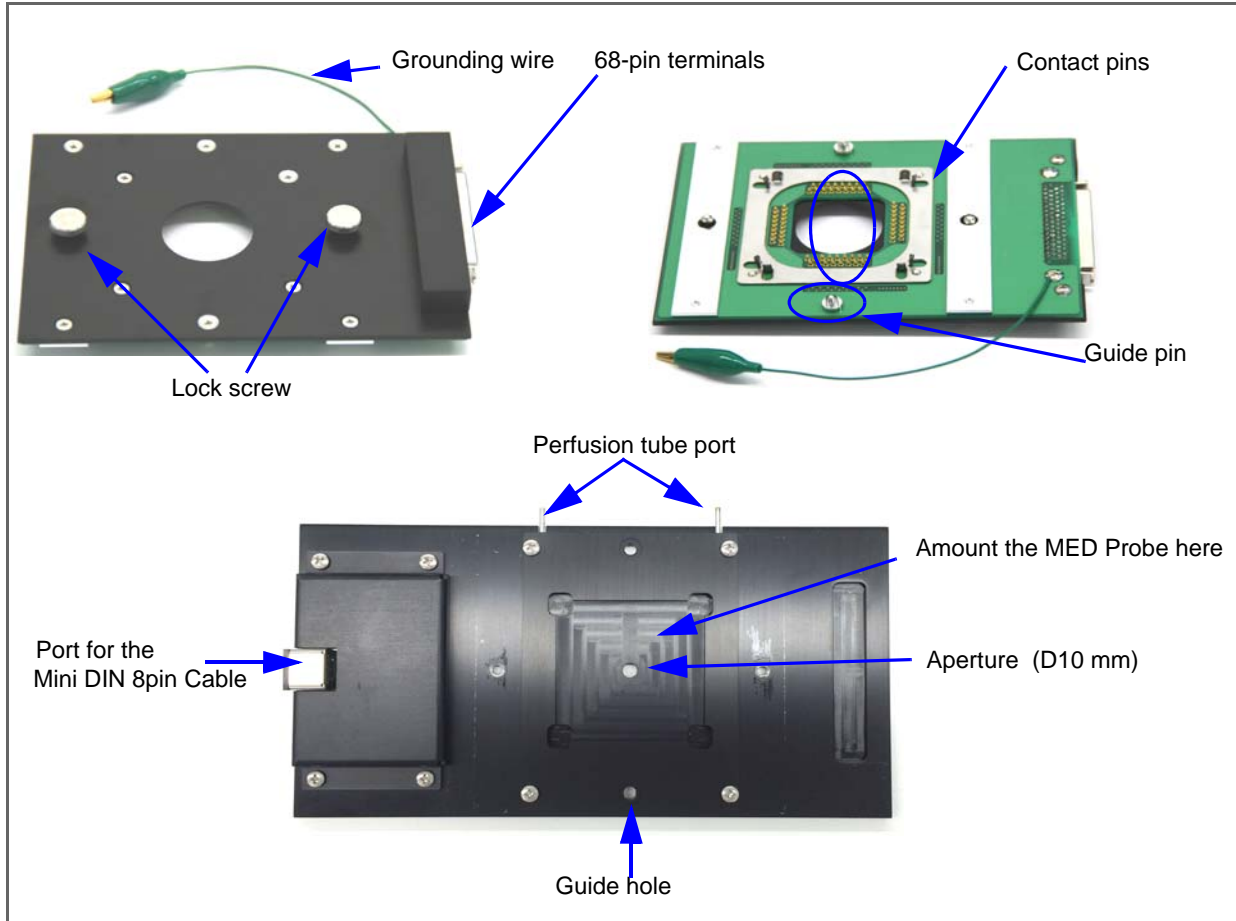

Figure 2. Connector unit. Top unit connects the MED Probe to the Head amplifier (top) and the Bottom unit incorporates heater (bottom).

Temperature controller



Figure 3. Temperature controller. Front view (left) and back view (right).

Accessories



Figure 4. Accessories for the MED ThermoConnector.

- (1) MED Connector Cable (68 pin):
Connect the 68 pin output terminal to the INPUT in the MED64 Head Amplifier (MED-A64HE1S).
- (2) Mini DIN 8pin Cable:
Connect the Connector unit to the Temperature controller.
- (3) Power supply unit:
power cable for the Temperature controller.

CAUTION:

- Do NOT use any cables other than provided by Alpha MED Scientific. Use of other cable will damage the unit.
- Particularly, do NOT to use any other Power cable. Use of it will damage the Temperature controller.

3. Installation

3-1. Orientation for the Connector unit

Place the Connector unit with its terminal oriented towards the right side. Channel 1 is assigned to the top-left while channel 64 is assigned to the bottom-right on the MED ThermoConnector.

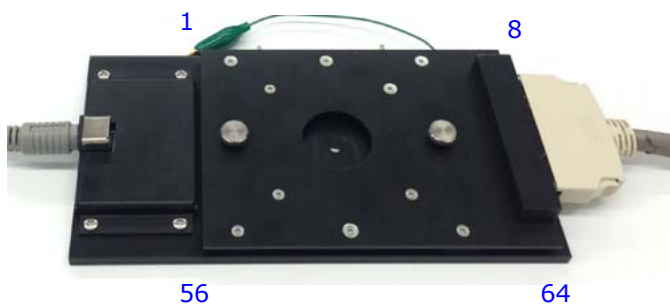

Figure 5. Orientation for the MED ThermoConnector

3-2. Installing the MED ThermoConnector

- Please read product manuals for all components and operating instruction for the MED64-Basic (or Plex 4/8) System.

The Figure 6 and 7 shows MED64-Basic System installed in a lab bench.



Figure 6. MED64-Basic System with perfusion system installed on a lab bench.



Figure 7. The MED64-Basic System with the Connector Cover installed on a lab bench.

1. Place the MED ThermoConnector **on a stable table**.
2. Make sure that Connector unit is located **AWAY** from:
 - Any equipment which generates an electric or magnetic field (e.g., power supply unit, peristaltic pump, heater).
 - Direct stream from air-conditioning or any other environment regulation system, or sunlight.
3. Make sure that the Temperature controller is located **AWAY** from the Connector unit.
4. Connects the 68 pin output terminals of the Connector unit to the INPUT terminal in the MED64 Head Amplifier (MED-64HE1S) with the MED Connector Cable (68 pin). Connect the side which has the ground wire to the MED64 Head Amplifier.
5. Connect the Ground wire attached to the Connector cable to the SIGNAL GND in the MED64 Head Amplifier (MED-A64HE1S) (Figure 8,10).
 - Let the ground wires for all Connectors go **THROUGH** the hole at the GND (Figure 10, most right) to secure the grounding.
6. Connect the Connector unit to the Temperature controller.
 - Please note that the port for the Connector unit is **NOT** symmetric.

3. Installation

7. Connect the Power cable of the Temperature controller to the same power strip where the MED64 Main Amplifier and MED64 Head Amplifier are connected (Figure 8).

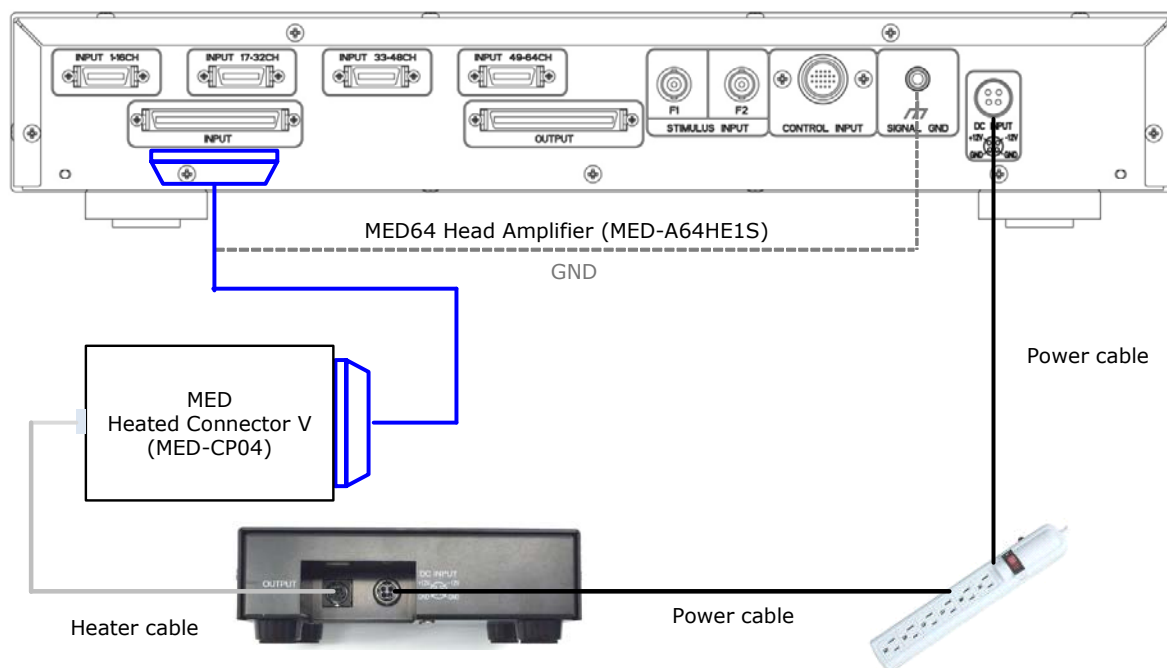

Figure 8. Connection between MED ThermoConnector and MED64 Head Amplifier.

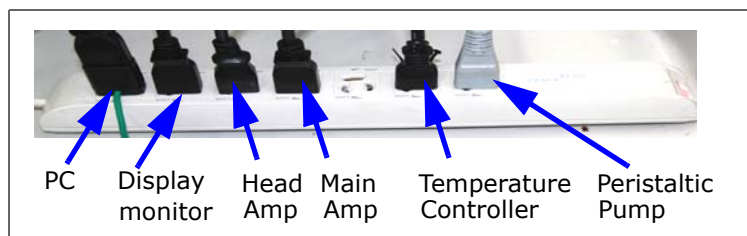

Figure 9. Ground the Temperature controller by connecting to the same power strip to amplifiers.



Figure 10. Connection between the MED ThermoConnector and amplifiers. Connection for the Connector cable (left), Connection for amplifiers (middle) and grounding for the MED Connector cable (right).



Important tips for the installation

- Place the Connector unit AWAY from:
 - The Temperature controller.
 - Any other equipment generating electric/magnetic field (e.g. Power supply, Peristaltic pump).
 - Direct stream from air-conditioning or any other environment regulation system.
- The Connector cable is sensitive to noise and vibration. Make sure:
 - it is AWAY from any other equipment generating electric/magnetic field (e.g., power supply, Peristaltic pump). Particularly pay extra attention so that it will NOT touch power supply units.
 - it is placed on a table and unmoved. The best location for the cable is under the Head Amplifier.

Installing with the perfusion system

When the MED ThermoConnector is used with perfusion system, connect perfusion inlet-outlet tubes to the "Perfusion tube ports" so that solution can be warmed before being sent to the MED Probe. (Refer to Figure 11.) Clean the tube with double distilled water after each experiment.

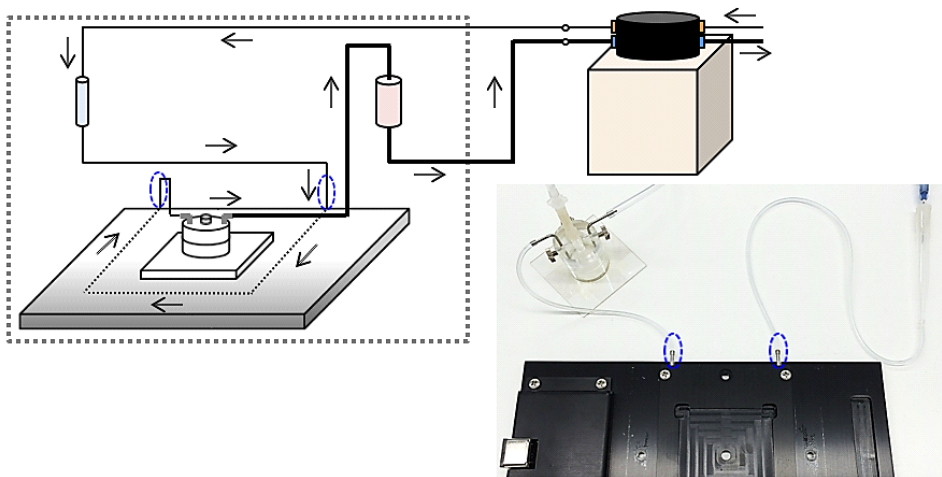

Figure 11. Connection for the perfusion tubes.

Connect the grounding wire (green wire attached to the connector unit) to the platinum wire (additional reference electrode) built into the Perfusion cap for grounding (Refer to Figure 16 in the page 12).

Installing on a microscope stage

The bottom unit for the MED Connector has an aperture (D: 5 mm) which allows you to observe biological sample with a microscope during recording.

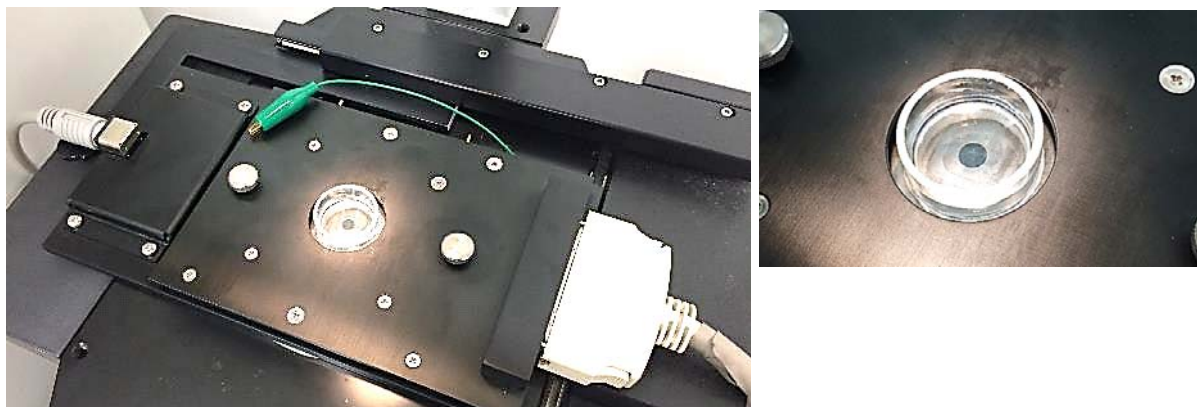

Figure 12. The Connector unit installed on a microscope stage.

Use a microscope which has external power supply to avoid introductions of noise.



NOTICE:

Do NOT use a microscope that incorporate its power supply, that interfere your signal recording with large noise.

Figure 13.

If 60Hz noises at all 64 channel are present, ground the microscope to the GND terminal on the MED64 Head Amplifier. Make sure to connect "exposed metal part" (e.g. screw) in the microscope to the GND terminal. Test with several different "metal part" to suppress the noise the most. It is recommended to fix the grounding cable onto the microscope firmly (Figure 14).

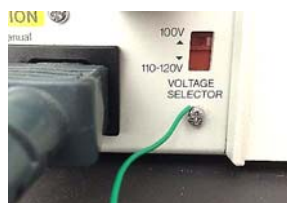

Figure14. An example for grounding a microscope. Connect "metal part" to the GND terminal in the MED64 Head Amplifier.

4. Instruction for use

4-1. Installing the MED Probe onto the MED ThermoConnector

1. Loosen the lock screws on the Connector unit and remove the top unit.
 - Loosen the both screws at the same time. Doing one first will make loosening the other difficult.
2. Clean the terminal for the MED Probe with kimwipe before loaded. (Figure 15 most-right). Particularly, clean it with kimwipe soaked with 70% ethanol when a MED Probe is taken out from a humidified incubator.
 - The leads in the MED Probe contact with gold pins in the MED ThermoConnector. Salt residue buildup (or even finger prints) on the leads can rust the contact pins.
3. Place the MED Probe filled with solution in the square guide on the bottom unit, and then tighten the lock screws.

CAUTION:

- DO NOT touch the contact pins with your bare hands or finger tips. This may cause rust and adversely affect conduction.
- Spilling liquid onto the pins will cause rust and adversely affect conduction. Be extremely careful not to get the pins wet, especially with saline solution.
- Avoid over-tightening the lock screws and pressing the spring-loaded contact pins or probe guide too tightly.

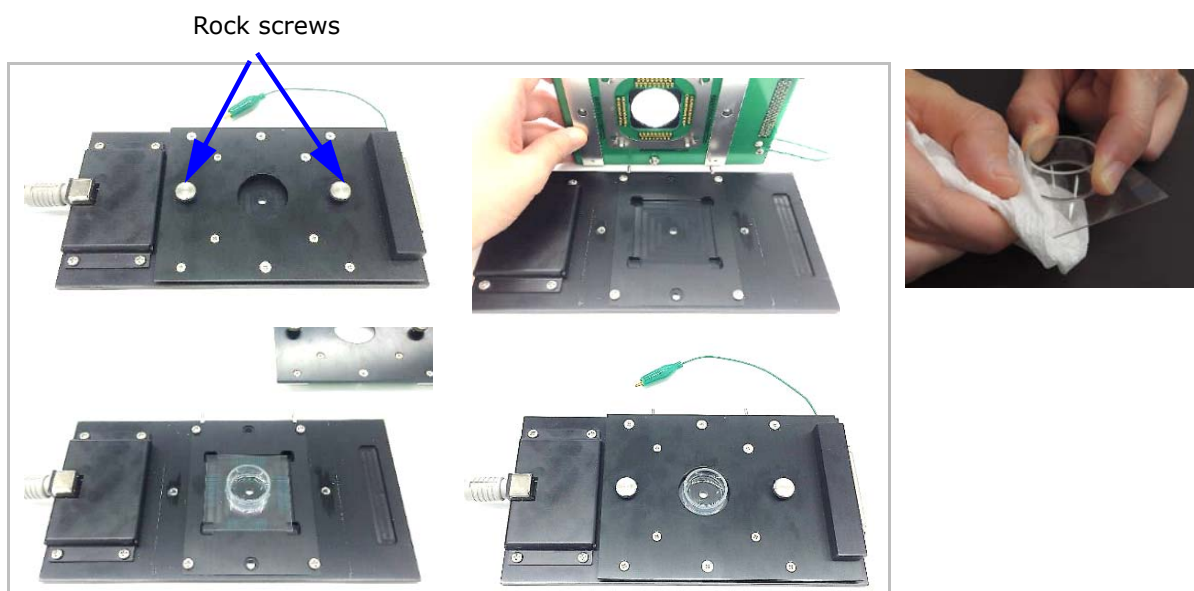

Figure 15. Mounting the MED Probe onto the MED ThermoConnector (left). Clean the terminal for the MED Probe with kimwipe before mounting the Probe (right).

Grounding the additional ref. electrode (platinum wire)

When additional ref. electrode (platinum wire) is used (e.g. platinum wire in the Perfusion Cap), make sure to ground it to the MED ThermoConnector with the green ground wire. Otherwise, large noise will be introduced.

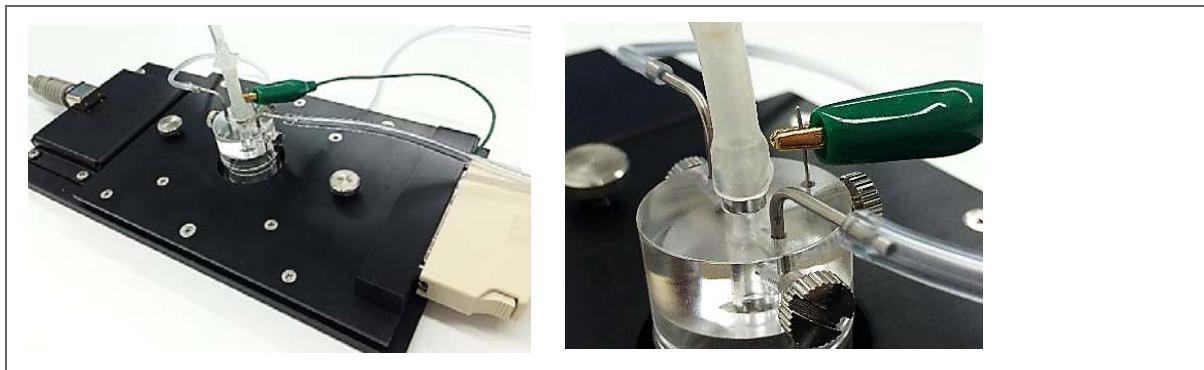

Figure 16. Grounding the additional ref. electrode (platinum wire) incorporated in the Perfusion cap.

4-2. Setting temperature

It takes several minutes for the temperature in the bottom of MED Probe to achieve the “set temperature”. Thus, it is strongly recommended to power on the Temperature controller BEFORE mounting the MED Probe.

1. Power on the Controller. The display panels shows:
(A) measured temperature on the left and
(B) set temperature on the right.
2. Adjust the “set temperature” to your desired value using the Down/Up keys in the bottom.

CAUTION:

The 3 keys on the most left-bottom in the display are used for initial calibration ONLY. Do NOT use those keys.

(A) Measured temperature (B) Set temperature

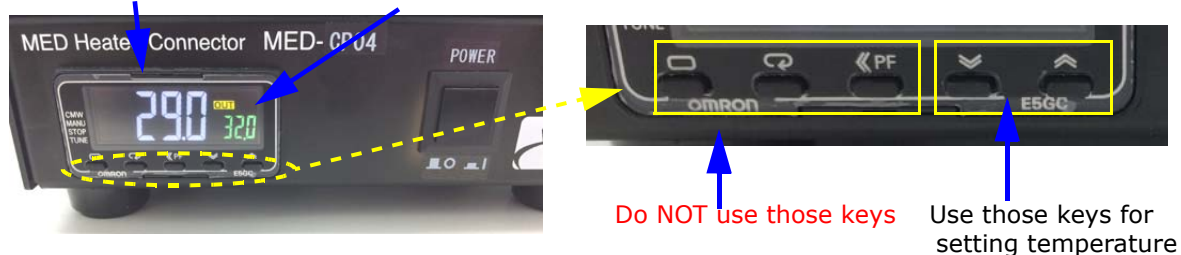

Figure 17. Display panel for the Temperature controller.

4-3. Recommended temperature and important notice to achieve a temperature stability

In order to avoid the changes and fluctuations in temperature, please **make sure that the top of the MED Probe is covered during your experiments**. Perfusion Cap or MED Connector Cover is available for this purpose. **Place the MED ThermoConnector away from the direct stream from air-conditioning or any other environment regulation system.**

The Table 1 shows the temperatures which were achieved at the bottom of the MED Probe chamber in our validation test with:

- Placing the Connector unit on a lab bench or microscope stage.
- **Open-top (without covering the top of the MED Probe chamber).**

Set temperature (at RT 25°C)	Temperature achieved at			
	Lab bench		Microscope stage	
	Without perfusion	With perfusion	Without perfusion	With perfusion
32 °C	31.5 °C - 32.5 °C	29.5 °C - 30.5 °C	31 °C - 32 °C	29.5 °C - 30.5 °C
37 °C	36.5 °C - 37.5 °C	NA	34 °C - 35 °C	NA

Table 1.

Note:

- The accuracy on the microscope stage may change depending on the stage materials. A microscope with metallic stage was used for the validation.
- The MED ThermoConnector was pre-calibrated so that the temperature for the bottom of MED Probe chamber will NOT go over 37 degree with consideration of use for cardiomyocytes.

Based on our validation test it is recommended to

- Place the ThermoConnector and controller at RM25°C and
- Adjust your set-temperature as shown in the Table 2 depending on where or in which condition it is used:

Desired temperature (at RT 25°C)	Set temperature at			
	Lab bench		Microscope stage	
	Without perfusion	With perfusion	Without perfusion	With perfusion
32 °C	32 °C	34 °C *1	32.5 °C	34 °C
37 °C	37 °C	NA	39.5 °C	NA

Table 2.

*1. This is the recommendation when the Perfusion Cap is used.

5. Maintenance

5-1. Cleaning of the contact pins

The 64 leads in a MED Probe are connected to the Connector with small gold contact pins. Uncleaned contact pins can cause noise or faulty recordings. Clean the contact pins several times while pushing them with a lint-free cloths (e.g. Lenses cloth for glasses) if dirty pins cause noise or any other problems.

If some contact pins are stuck and unmovable, your connector needs to be repaired. Contact your local distributor or our technical support team.

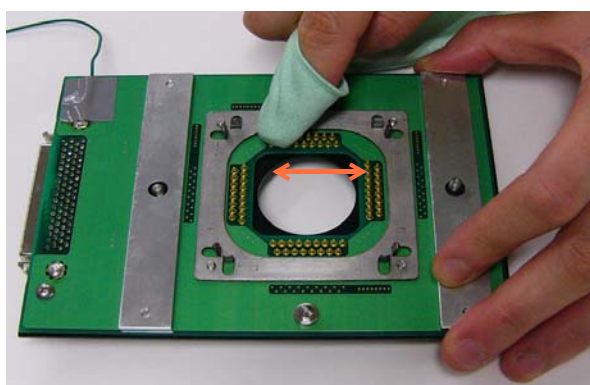

Figure 18. Cleaning the contact pins.

Be extremely careful NOT spill solution over the contact pins. If this happens, stop perfusion immediately and clean the contact pins gently with a clean cloth soaked with double-distilled water to remove any sediment or salts, and then allow to dry.

Avoid using alcohol. Alcohol may remove the lubricant which is necessary for the pins to move.

5-2. Cleaning of the perfusion pipe incorporated into the Connector unit

The bottom unit of the Connector unit built-in pipe for perfusion. When the MED ThermoConnector is used with perfusion, clean the entire perfusion tube by:

1. Perfusing distilled water for at least 10 minutes, and then
2. Drying it by circulating air for 10 minutes.

Please clean the tube/pipe after EVERY experiment. Replace the perfusion tubing and dripper often.

The Perfusion pipe for the Connector unit can be removed and cleaned with the procedure shown in the Figure 19. If smooth flow cannot be achieved even with new perfusion tubing, clean the pipe with one of the following methods:

- Clean it in a ultrasonic bath.
- Soak it into 70% ethanol and leave it for 3-4 hours.
- Soak it into Acetone and leave it for overnight.

Caution:

- Do NOT use plastic box for cleaning with Acetone (Acetone might erode plastic).

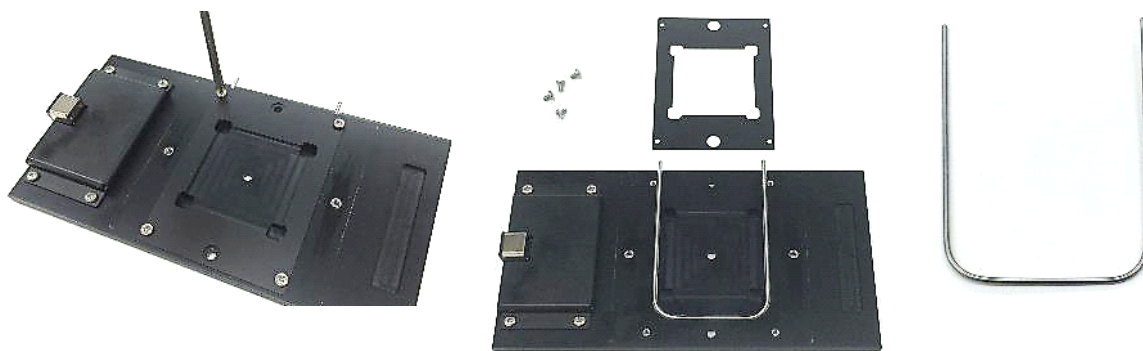

Figure 19. Removing the perfusion pipe from the bottom unit.

5-3. Re-connecting the Grounding cable for the Connector unit

The green Grounding wire attached to the Connector unit is used for grounding the platinum wire (additional reference electrode) to the Connector. When the platinum wire is used, make sure to ground it using this cable. (Otherwise, large noise will appear.) If this cable is disconnected, solder it to the Connector unit (Figure 20).

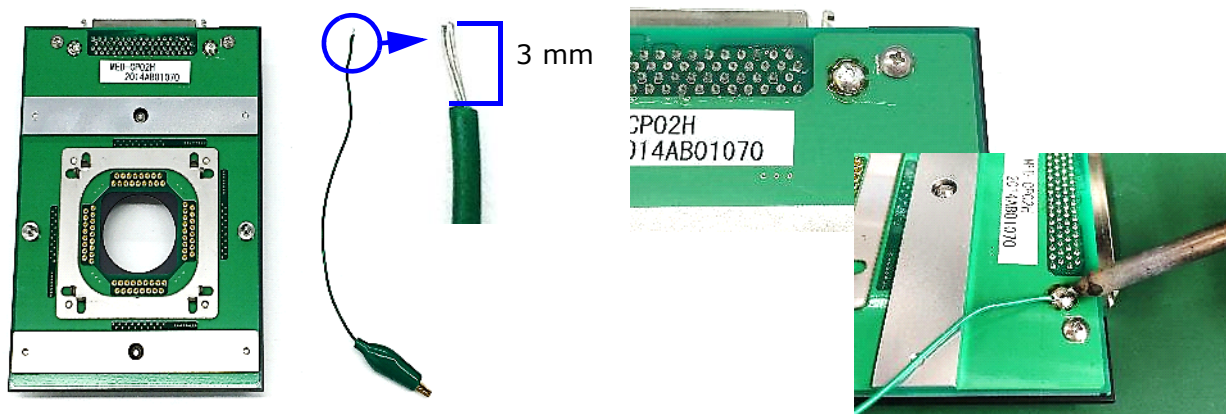

Figure 20. Reconnecting the grounding cable to the Connector unit.

5-4. Sterilization

Wipe it with a lint-free cloth soaked in 70% ethanol, and allow to dry.

- Cleaning with ethanol is only for outside connector, but NOT for the gold contact pins.

CAUTION:

- Do NOT autoclave as it may damage the MED Connector.
- Do NOT wipe the contact pins with a cloth soaked with ethanol. Alcohol may remove the lubricant which is necessary for the pins to move.

5-5. Storage

Store in a cool dry area. Avoid exposure to high temperatures or humidity. Store it WITHOUT mounted MED Probe when it is not used for long term.

6. Troubleshoot

When noise appears during your experiments, it is important to identify where it comes from. Representative reasons are:

- Damaged electrodes in the MED Probes.
- Uncleaned and/or damaged contact pins in the Connector.
- Loosen contacts for the cables.
- Incorrect grounding.
- Equipment that generates an electric or magnetic field (e.g. power supply, peristaltic pump, heater) located close to amplifiers, connector, or/and connector cable.
- Perfusion.
- Environment.

If noise appears at all 64 channels, the reason is likely to be in inappropriate grounding, environment, or amplifiers.

On the other hand, if noise is seen in specific channels, the reason is likely to be in the Connector, Connector cable, or Probes. To identify the reason, rotate the MED Probe 90 degree. If the noise still remains at the same channels it is likely caused by poor contacts at the gold pins. Clean the pins with lint-free cloths (See page 14).

7. Cautions

- DO NOT touch the contact pins on the connector unit with bare hands or fingertips. This may cause rust and adversely affect conduction.
- Clean the terminal for the MED Probe with a Kimwipe before mounting onto the ThermoConnector. Particularly, clean it with a kimwipe wet with ethanol when the MED Probe is taken from a humidified incubator.
- DO NOT spill medium or any other liquid on the both units. Particularly, pay special attention not to spill medium over the contact pins in the Connector unit.
- Do NOT press the contact pins and probe guide for the Connector unit excessively. It may damage and affect conduction.
- DO NOT give strong mechanical shock by putting heavy material on the unit or dropping the both units.
- DO NOT tighten the lock screws excessively to avoid damaging them. (The torque of the screw should not exceed 8kg/cm.)



What should I do if medium spilled on the contact pins?

Stop the perfusion immediately and clean the contact pins gently with a clean cloth soaked with double-distilled water to remove any sediment or salts, and then allow to dry.

Avoid using alcohol. Alcohol may remove the lubricant which is necessary for the pins to move.

8. The terminal arrangement of electrodes on the MED Probe and the MED ThermoConnector

The MED Probe does not have orientation while the Connector unit in the MED ThermoConnector does. Channel 1 is located on the top left and channel 64 on the bottom right when the connector terminal is located on the right hand side (as shown in the Figure 21). This channel arrangement is the same even if the probe is rotated 90 or 180 degrees, since the channel number is relative to its location in the Connector unit.

Figure 21 shows the terminal arrangement for the Connector unit. MED Probe has 4 reference electrodes as well as 64 (or 61) recording electrodes. The four reference electrodes are connected to the Connector unit separately.

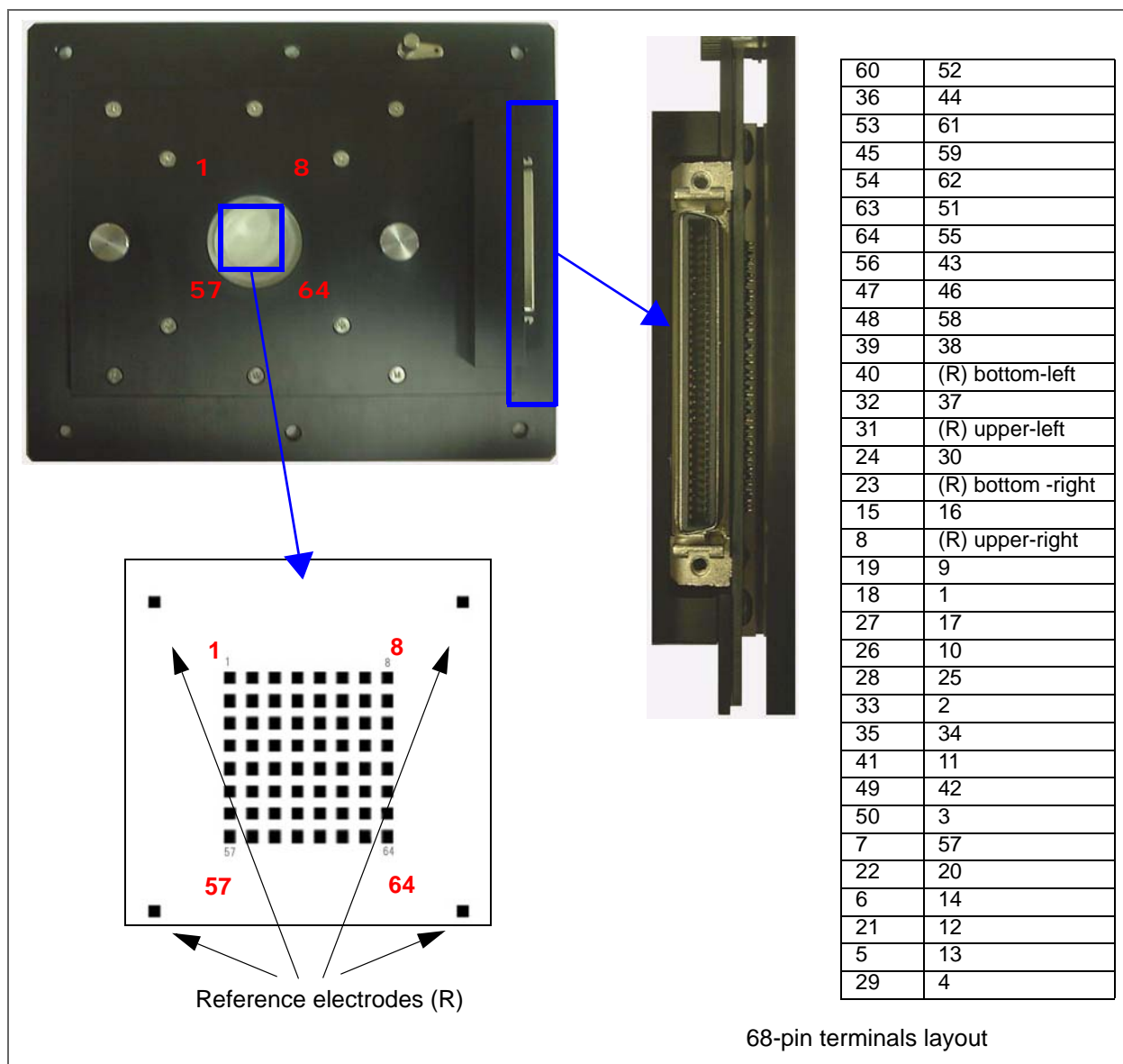

Figure 21. Orientation of the Connector unit and terminal assignment for the Connector unit.

9. Warranty

This product will be repaired with new or refurbished parts, free of charge, for one (1) year from the date of original purchase in the event of a defect in materials or workmanship.

The product warranty covers failures due to defects in materials or workmanship which occur during normal use. It does NOT cover damage incurred during shipment or problems which are caused by products not supplied by Alpha MED Scientific. In addition, this warranty does not cover problems resulting from alteration, accident, misuse, neglect, faulty installation, maladjustment of user controls, improper maintenance, modifications or service by anyone other than AMS or damage attributable to acts of God.

10. Specifications

Connector unit

MED Probe securing mechanism	Screw down
Signal output	68-pin terminals
Printed circuit board	4 layers -1st, 4th layers are ground -2nd, 3rd layers contain signal line
Contact resistance	< 30mΩ
Material	Aluminum (Gold for contact pins)
Heater device	2 Transistors
Sensor device	Centigrade temperature sensor IC
Temperature accuracy (for solution in the MED Probe)	< +/- 1.0 °C
Range of verified accuracy	32 °C - 37 °C (RT=25°C)
Weight	510 g
Dimensions	W200 x D105 x H20 (mm)

Temperature controller

Temperature controller unit	OMRON E5GC
Control method	Auto-tuning PID temperature control
Resolution	0.1 °C
Power supply voltage	DC +/- 12V
Consumption current	+1A, -0.1A (typ.). +2A (max.)
Weight	350 g
dimensions	W150 x D110 x H50 (mm)

Accessories

Power supply unit	
Input	AC 100-240V (50-60 Hz)
Output	DC +/-12V
MED Connector Cable (68pin)	
Length	2 m
Mini DIN 8pin Cable	
Length	2 m

Specifications may not be satisfied depending upon the type of computer or operating environments used. Only for use in animal studies research. Specifications and external appearance are subject to change without notice.

December 1, 2016



Alpha MED Scientific Inc.

Saito Bio-Incubator 209, 7-7-15, Saito-asagi,
Ibaraki, Osaka 567-0085, Japan

Phone: +81-72-648-7973 FAX:+81-72-648-7974
<http://www.med64.com> support@med64.com

Manufactured by **Alpha MED Scientific Inc.**

©2016 Alpha MED Scientific Inc.